

900-LFC Compact Low Frequency Control Element

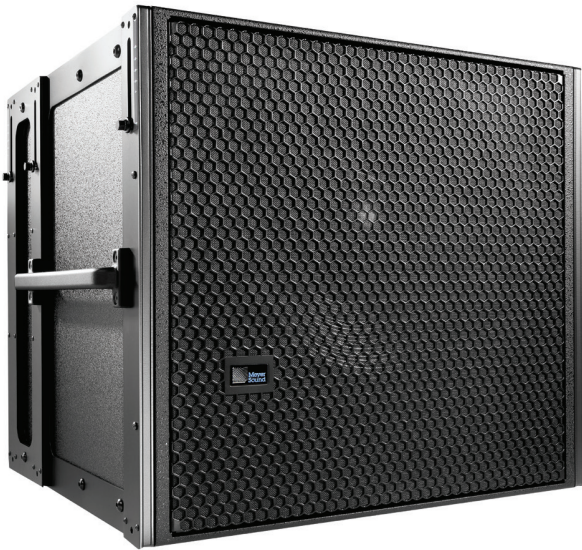

(Shown with optional Quickfly® rigging)

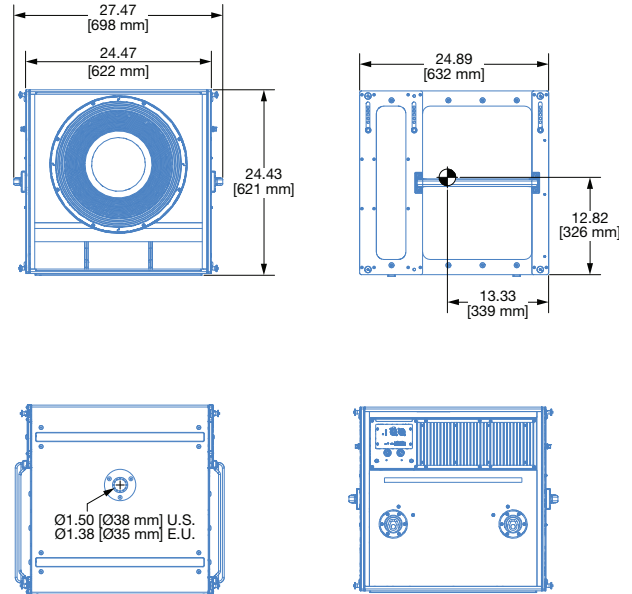

(Dimensions shown for Rigging version)

Meyer Sound’s 900-LFC compact low-frequency control element reproduces low frequencies at high continuous output levels with extremely low distortion. The 900-LFC offers the same sonic linearity as Meyer Sound’s 1100-LFC low-frequency control element in a smaller, lighter cabinet, making it ideal for building scalable systems to suit touring applications or fixed installations of any size.

A newly designed class D amplifier affords unprecedented efficiency to the 900-LFC, significantly lowering distortion while reducing power consumption and operating temperature. A single, field-replaceable module contains the on-board amplifier and control circuitry.

In addition to pairing with LEOPARD™ systems, the 900-LFC integrates easily with other Meyer Sound loudspeaker systems, including LEO-M™, LYON™, and ULTRA Series loudspeakers.

Meyer Sound’s Galileo® GALAXY Network Platforms, which provide matrix routing, alignment, and processing for array components,

can drive LEOPARD and 900-LFC loudspeakers. To guarantee optimum performance, use Meyer Sound’s MAPP™ system design tool to design systems with the 900-LFC.

LEOPARD and 900-LFC loudspeakers work with Meyer Sound’s RMS™ remote monitoring system, which provides comprehensive monitoring of system parameters from a Mac® or Windows®-based computer.

The 900-LFC is available with or without Meyer Sound’s QuickFly® rigging. When equipped with the optional MRK-900 rigging kit, the captive GuideALinks™ enable flying of the 900-LFC from the MG-LEOPARD/900 multipurpose grid in LEOPARD arrays without a transition frame. Also use the MG-LEOPARD/900 grid for groundstacks with uptilt or downtilt. Or fly 900-LFCs separately as a subwoofer array with variable splay angles of 0°, 1.25°, 2.5°, 3.75°, or 5°.

Transport both versions of the 900-LFC in stacks with the optional MCF-900 caster frame.

FEATURES AND BENEFITS

- Compact cabinet with small footprint and extraordinary power-to-size ratio
- High peak power output with extremely low distortion
- Exceptional linearity, transient reproduction, and low-frequency clarity
- Self-powered for simplified setup and increased reliability
- Stackable and flyable in regular and cardioid arrays, with tilt and splay options
- Integral pole-mount receptacle easily pairs the subwoofer with ULTRA Series loudspeakers

APPLICATIONS

- Scalable low-frequency control (very long arrays possible) for touring applications or fixed installations of any size
- Clubs, theaters, houses of worship, corporate AV, and theme parks
- Low-frequency complement for LEO-M, LYON, and LEOPARD systems

ACCESSORIES AND ASSOCIATED PRODUCTS

MG-LEOPARD/900 Multipurpose Grid: Flies LEOPARDS, 900-LFCs, and mixed arrays. Also supports LEOPARD and 900-LFC ground-stack configurations.

PBF-LEOPARD Pull-Back Frame: Provides pull-back for extreme downtilt of flown LEOPARD and 900-LFC arrays, and allows additional downtilt in ground-stacked arrays.

MVP Motor Vee Plate: Attaches to MG-LEOPARD/900 grid and fine tunes horizontal aim of LEOPARD and 900-LFC arrays.

MG-LEOPARD/900 Ground-stack Tilt Kit: Includes two angle feet that attach to the rear of the MG-LEOPARD/900 grid that can add up to eight degrees of tilt to the entire ground-stack array.

MCF-900 Caster Frame: Safely transports up to two 900-LFCs, making it easy to assemble and disassemble arrays in blocks of two cabinets. This adjustable frame accommodates 900-LFC cabinets with or without rigging.

MDM-5000 Distribution Module: MDM-5000 units conveniently power 900-LFC systems, routing up to six channels of AC power, balanced audio and RMS signals to the loudspeakers.

Galileo GALAXY Network Platform: The Galileo GALAXY Network Platform provides state-of-the-art audio control technology for loudspeaker systems with multiple zones. With immaculate sonic performance, it provides a powerful tool set for corrective room equalization and creative fine-tuning for a full range of applications.

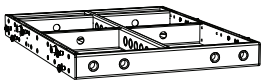

MG-LEOPARD/900 Multipurpose Grid

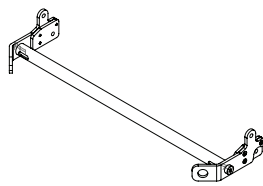

PBF-LEOPARD Pull Back Frame

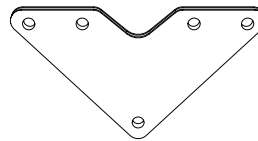

MVP Motor Vee Plate

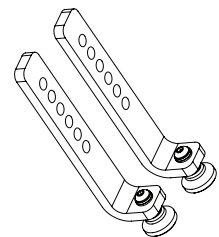

MG-LEOPARD/900 Ground-stack Tilt Kit

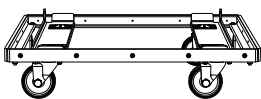

MCF-900 Caster Frame



MDM-5000 Distribution Module

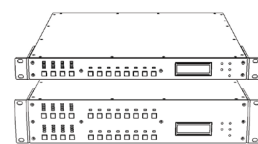

GALAXY Network Platform

SPECIFICATIONS

ACOUSTICAL ¹	
Operating Frequency Range ²	30 Hz – 125 Hz
Frequency Response ³	32 Hz – 115 Hz ±4 dB
Phase Response	40 Hz – 110 Hz ±30°
Linear Peak SPL ⁴	133 dB with crest factor >10 dB (M-noise) , 133 dB (Pink noise), 134.5 dB (B-noise)
COVERAGE	
	360° (single unit); varies with number of units and configurations
TRANSDUCERS	
Low Frequency	One 18-inch, dual-coil, long-excursion cone driver; 2Ω nominal impedance
AUDIO INPUT	
Type	Differential, electronically balanced
Maximum Common Mode Range	±15 V DC, clamped to earth for voltage transient protection
Connectors ⁵	XLR 5-pin female input with male loop output; XLR 3-pin female connectors available to accommodate only balanced audio (no RMS signals)
Input Impedance	10 kΩ differential between pins 2 and 3
Wiring	Pin 1: Chassis/earth through 1 kΩ, 1000 pF, 15 V clamped network to provide virtual ground lift at audio frequencies Pin 2: Signal + Pin 3: Signal - Pin 4: RMS Pin 5: RMS Case: Earth ground and chassis
Nominal Input Sensitivity	6.0 dBV (2.0 V rms) continuous is typically the onset of limiting for noise and music
Input Level	Audio source must be capable of producing +20 dBV (10 V rms) into 600 Ω to produce the maximum peak SPL over the operating bandwidth of the loudspeaker
AMPLIFIER	
Type	Two-channel, open-loop, class D
Total Output Power ⁶	3100 W peak
THD, IM, TIM	< 0.02%
Cooling	Convection
AC POWER	
Connectors	powerCON 20 input with loop output
Automatic Voltage Selection	90–265 V AC, 50–60 Hz
Safety Rated Voltage Range	100–240 V AC, 50–60 Hz
Turn-on and Turn-off Points	90 V AC turn-on, no turn-off; internal fuse-protection above 265 V AC
CURRENT DRAW	
Idle Current	0.60 A rms (115 V AC), 0.49 A rms (230 V AC), 0.63 A rms (100 V AC)
Maximum Long-Term Continuous Current (>10 sec)	4.9 A rms (115 V AC); 2.5 A rms (230 V AC); 5.2 A rms (100 V AC)
Burst Current (<1 sec) ⁷	8.8 A rms (115 V AC), 4.7 A rms (230 V AC), 11.0 A rms (100 V AC)
Maximum Instantaneous Peak Current	18.2 A peak (115 V AC), 9.2 A peak (230 V AC), 20.6 A peak (100 V AC)
Inrush Current	< 20 A peak
RMS NETWORK	
	Equipped with two-conductor twisted-pair network, reporting all operating parameters of amplifiers to system operator's host computer.

SPECIFICATIONS, CONT'D.

PHYSICAL	
Dimensions without Rigging	W: 27.43 in (697 mm) x H: 24.43 in (621 mm) x D: 24.89 in (632 mm)
Dimensions with Rigging	W: 27.47 in (698 mm) x H: 24.43 in (621 mm) x D: 24.89 in (632 mm)
Weight without Rigging	136 lb (61.7 kg)
Weight with Rigging	159 lb (72.1 kg)
Enclosure	Premium multi-ply birch with slightly textured black finish
Protective Grille	Powder-coated, hex-stamped steel with acoustical black mesh
Rigging	Optional end frames with captive GuideALinks secured with 0.3125 in x 0.63 in quick release pins that allow 0°, 1.25°, 2.5°, 3.75°, or 5° splay angles; detachable side handles. Rigging supports ground-stacked, flown, and cardioid configurations.
Pole Mount	U.S. version: 1.5 in (38 mm) E.U. version: 1.375 in (35 mm and M20 thread at the bottom)

NOTES

- Loudspeaker system predictions for coverage and SPL are available in Meyer Sound's MAPP System Design Tool.
- Recommended maximum operating frequency range. Response depends on loading conditions and room acoustics.
- Measured in half-space with pink noise at 4 m, 1/3-octave frequency resolution.
- Linear Peak SPL** is measured in half-space at 4 m referred to 1 m. Loudspeaker SPL compression measured with M-noise at the onset of limiting, 2-hour duration, and 50-degree C ambient temperature is <2 dB.
M-noise is a full bandwidth, (10 Hz–22.5 kHz) test signal developed by Meyer Sound to better measure the loudspeaker's music performance. It has a constant instantaneous peak level in octave bands, a crest factor that increases with frequency, and a full bandwidth Peak to RMS ratio of 18 dB. The presence of a greater-than (>) symbol with regard to crest factor indicates it may be higher depending on EQ and boundary loading.
Pink noise is a full bandwidth test signal with Peak to RMS ratio of 12.5 dB.
B-noise is a Meyer Sound test signal used to ensure measurements reflect system behavior when reproducing the most common input spectrum, and to verify there is still headroom over pink noise.
- Pins 4 and 5 (RMS) only included with XLR 5-pin connector that accommodates both balanced audio and RMS signals.
- Peak power based on the maximum unclipped voltage the amplifier will produce into the nominal load impedance.
- AC power cabling must be of sufficient gauge so that under burst current rms conditions, cable transmission losses do not cause the loudspeaker's voltage to drop below the specified operating range.

ARCHITECTURAL SPECIFICATIONS

The loudspeaker shall be a compact, self-powered, linear, low-distortion, low-frequency control element and shall be capable of flown, ground-stacked, and cardioid configurations. Its transducer shall be one 18-inch, dual-coil, long-excursion cone driver.

The loudspeaker shall incorporate internal processing and a two-channel, open-loop, class D amplifier. Processing shall include equalization, phase correction, and driver protection. Performance specifications for a typical production unit, measured at 1/3-octave resolution, shall be as follows: operating frequency range shall be 30–125 Hz; frequency response shall be 32–115 Hz ±4 dB, measured in half-space with pink noise at 4 m, 1/3-octave frequency resolution; phase response shall be 40–110 Hz ±30°; linear peak SPL shall be 133 dB with crest factor >10 dB, measured in half-space with pink noise at 4 m referred to 1 m.

Audio connectors shall be XLR 3-pin, female and male, accommodating balanced audio, or XLR 5-pin, accommodating both balanced audio and RMS.

The internal power supply shall perform EMI filtering, soft current turn-on, and surge suppression. Power requirements shall be nominal 100, 110, or 230 V AC line current at 50–60 Hz. UL and CE operating voltage range shall

be 100–240 V AC at 50–60 Hz. AC power connectors for input and loop output shall be powerCON 20. Maximum long-term continuous current draw shall be 4.9 A rms at 115 V AC, 2.5 A rms at 230 V AC, and 5.2 A rms at 100 V AC.

The loudspeaker shall include an RMS remote monitoring system module. Components shall be mounted in an optimally tuned, vented enclosure constructed of premium multi-ply birch with a slightly textured black finish. The front protective grille shall be powder-coated, hex-stamped steel with acoustical black mesh. Optional rigging for the enclosure shall include end frames with captive GuideALinks for linking units in vertical arrays at splay angles of 0°, 1.25°, 2.5°, 3.75°, or 5°.

Dimensions without rigging shall be W: 27.43 in (697 mm) x H: 24.43 in (621 mm) x D: 24.89 in (632 mm). Dimensions with optional rigging shall be W: 27.47 in (698 mm) x H: 24.43 in (621 mm) x D: 24.89 in (632 mm). Weight shall be 136 lb (61.7 kg). Weight with optional rigging shall be 159 lb (72.1 kg).

The loudspeaker shall be the Meyer Sound 900-LFC.